



**3**  
**YEAR FULL**  
**WARRANTY!**

**OUR**  
**STANDARD**

# Platform

The trailer for those who think more broadly

→ PL: Platform

→ PL HD: Platform HD



 **WORKS FOR YOU**

[WWW.SARIS.NET](http://WWW.SARIS.NET)

## For every skilled professional

The SARIS Platform is ideal for transporting long items, large volumes and vehicles. This includes anything from pallets and beams, to planks and steel profiles. Loading goods is easy thanks to the large surface and low standard load floor as well as the collapsible and removable side boards.

The SARIS Platform trailer has been developed and specially tested for use in by the everyday professional. The well thought through options and accessories make the SARIS Platform trailer suitable for any purpose and user.

Discover the possibilities of the SARIS Platform trailer.

[WWW.SARIS.NET](http://WWW.SARIS.NET)

**3**  
**YEAR FULL WARRANTY!**  
**OUR STANDARD**

## Unique features of the SARIS Platform:

- ✓ Lowered loading floor as standard
- ✓ Designed for long items and large volumes
- ✓ Extremely easy to install high cover
- ✓ SARIS Safety drive-on ramps with locking function help avoid dangerous ramp situations. Convenient handles included.
- ✓ Concealed lashing points with sound-absorbing rubber for flat loading
- ✓ 800 daN lashing points, net hooks and rope hooks
- ✓ Welded completely by robots with hot-dip galvanised chassis
- ✓ Easy to load thanks to 4 collapsible and removable side boards
- ✓ Available with a large load capacity of up to nearly 3000kg
- ✓ Very wide range of choices
- ✓ Sleek and robust black edition model (panels, floor and rims)
- ✓ Can be fitted entirely with LEDs
- ✓ Proven quality thanks to computer design, practise testing, test track and laboratory endurance tests
- ✓ Tri axle version for stability and heavy loads
- ✓ As standard with 15 mm wooden floor out of one piece Finnish birch wood



Usable length  
Min 206 cm - Max 406 cm



Usable width  
Min 150 cm - Max 204 cm



Usable height  
Sides 30 cm, optional: 35 cm sides



Weight  
Min 1350 kg - Max 3500 kg

SARIS Platform PL 406 204 3500 3 with high cover

 **WORKS FOR YOU**

# The SARIS Platform comes with following equipment as standard:

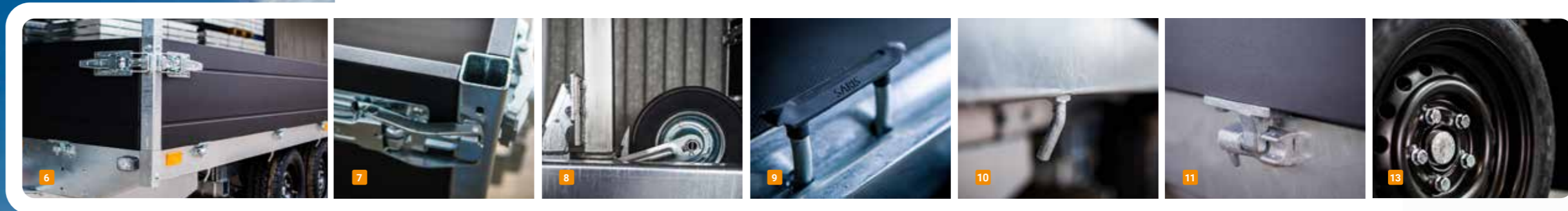

- 1 Lowered loading floor
- 2 Full welded frame (Sleeve profile)
- 3 More than 200 robot weldings
- 4 Mega stiff and torsion-free chassis
- 5 Full bath galvanized chassis
- 6 High strength aluminum sides
- 7 Aluminum sides with pk-fasteners
- 8 Strong jockey wheel
- 9 Anti-noise 800 daN hooks
- 10 Rope-hooks
- 11 Mesh hooks on hinge
- 12 Dark waterproof, 15 mm thick floor plate
- 13 195/50R13 tires with M+S coding and steel valves



## Choose the SARIS Platform that fits you!



SARIS Platform PL 256 150 1500 1



SARIS Platform PL 406 204 3500 3

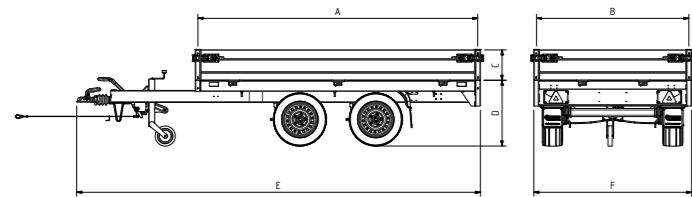

SARIS Platform PL 306 170 2000

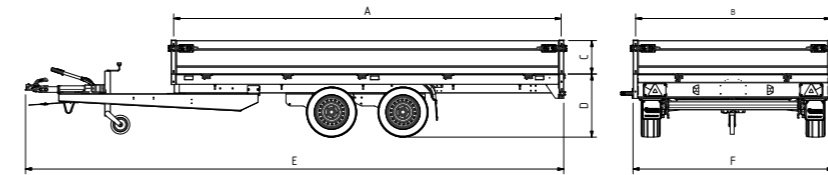

Technical data	PL 256 150 1350 1	PL 256 150 1500 1	PL 276 150 1350 1	PL 276 150 1500 1	PL 276 150 2000 2	PL 276 170 2000 2	PL 276 170 2700 2	PL 306 170 2000 2	PL 306 170 2700 2	PL 306 184 2700 2	PL 306 184 3500 2	PL 356 184 2700 2
Length (A) (cm)	256	256	276	276	276	276	276	306	306	306	306	356
Width (B) (cm)	150	150	150	150	150	170	170	170	170	184	184	184
Height sides (C) (cm)	30	30	30	30	30	30	30	30	30	30	30	35
Loading floor height (D) (cm)	66	66	66	66	65	65	65	65	65	65	67	68
Total length (E) (cm)	393	393	403	403	399	440	440	453	453	479	483	516
Total width (F) (cm)	163	163	163	163	163	183	183	183	183	197	197	197
Total Weight (kg)*	1350	1500	1350	1500	2000	2000	2700	2000	2700	2700	3500	2700
Own weight (kg)	319	318	328	326	383	406	435	421	449	465	532	517
Loading capacity (kg)	1031	1182	1022	1174	1617	1594	2265	1579	2251	2235	2968	2183
Tyre size	195/50R13C	195/50R13C	195/50R13C	195/50R13C	195/50R13C	195/50R13C	195/50R13C	195/50R13C	195/50R13C	195/50R13C	195/50R13C	195/50R13C
Single / Double / Tridem axle	Single	Single	Single	Single	Double	Double	Double	Double	Double	Double	Double	Double
T-shaped / V-shaped tow bar	V	V	V	V	V	V	V	V	V	V	V	V
Braked / unbraked	Braked	Braked	Braked	Braked	Braked	Braked	Braked	Braked	Braked	Braked	Braked	Braked
Leaf spring incl. shockabsorbers												

\* Tevens af te waarden naar een lager totaalgewicht.

Technical data	PL 356 184 3500 2	PL 406 184 2700 2	PL 406 184 3500 2	PL 406 204 2700 2	PL 406 204 3500 2	PL 406 204 3500 3
Length (A) (cm)	356	406	406	406	406	406
Width (B) (cm)	184	184	184	204	204	204
Height sides (C) (cm)	35	35	35	35	35	35
Loading floor height (D) (cm)	68	68	68	66	66	66
Total length (E) (cm)	520	566	570	564	568	568
Total width (F) (cm)	197	197	197	243	243	243
Total Weight (kg)*	3500	2700	3500	2700	3500	3500
Own weight (kg)	582	541	606	587	651	706
Loading capacity (kg)	2918	2159	2894	2113	2849	2794
Tyre size	195/50R13C	195/50R13C	195/50R13C	195/50R13C	195/50R13C	195/50R13C
Single / Double / Tridem axle	Double	Double	Double	Double	Double	Tridem
T-shaped / V-shaped tow bar	V	V	V	V	V	V
Braked / unbraked	Braked	Braked	Braked	Braked	Braked	Braked
Leaf spring incl. shockabsorbers			Optional		Optional	Optional



## Options\*

- 1 Black Edition (black floor, black wheels, black sides)
- 2 Sides 35 cm standard from 3.5 m length
- 3 Sides 35 cm standard from 3.5 m length Black Edition
- 4 U-Profile for SARIS Safety ramps
- 5 Prepared for SARIS Safety ramps
- 6 Ramps integrated
- 7 Prop stands
- 8 Shock absorbers
- 9 Spare wheel incl. clamp
- 10 Steel plate on floor
- 11 Winch incl. support (available from 3.5 m length and longer)
- 12 Tridem axle (available for 204 width with 3500kg total weight)
- 13 Fully LED-lighting
- 14 Heavy Duty jockey wheel (500kg, supported) (available from 3.5 m length at 3500 kg max. weight)
- 15 Leaf springs (available from 406 length at 3500kg)
- 16 Floor reinforcement at 406 204 dimensions for reduction of point loads
- 17 Railing instead of boards for size 406 204

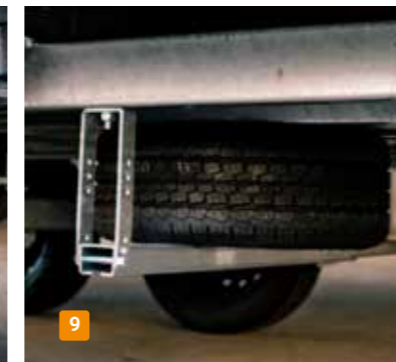
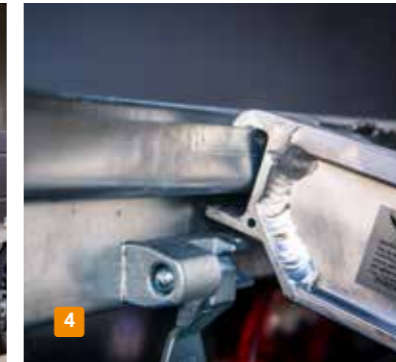

 → Build your trailer online!  
 Go to: [www.saris.net](http://www.saris.net)

\* All options are Ex works and available for multiple models. Ask your dealership for all possibilities.

## Accessories\*\*

- 1 Trailer net (large meshes)
- 2 High frontrack
- 3 Flat vinyl cover (light grey)
- 4 High vinyl cover (light grey)
- 5 Leaf rack 60 cm, from 306 also available in 90 cm
- 6 Leaf rack net (small meshes)
- 7 SARIS Safety ramp (1400 kg per ramp)
- 8 30 cm extension board set
- 9 30 cm extension board set Black Edition
- 10 Spare wheel incl. clamp
- 11 Security lock



→ Keep your trailer in top condition.  
Read more about our Service and Warranty  
on [www.saris.net](http://www.saris.net)

# SARIS Platform Heavy Duty

Back in the SARIS program and stronger than ever, the SARIS Platform Heavy Duty. The Platform Heavy Duty (HD) is stronger as standard thanks to the (hidden) structure in the frame of 10 cross beams and 4 main beams. This Platform Heavy Duty can transport the most extreme loads; from loose raw materials such as sand and stone, to heavy equipment such as construction machinery.

Of course, if you go out with the Heavy Duty every day, you must be able to rely on it one hundred percent and be able to handle it easily. It has a lower loading floor and a practical ball coupling. It is also prepared for ramps as standard. Add the practical to the super strong and voila, you have a trailer with which and on which you can build on.

[WWW.SARIS.NET](http://WWW.SARIS.NET)



**3**  
**YEAR FULL WARRANTY!**  
**OUR STANDARD**



The new PL 506 can rightly be called the founder of the completely new Heavy Duty segment within the SARIS product line. It does not just happen that a trailer becomes a Heavy Duty: these are the real tough guys for the really heavy work. Always designed as a 3.5 ton vehicle, fully welded chassis with the latest welding robots and equipped with LED lighting as standard.

## This makes the SARIS Platform Heavy Duty unique:

- ✓ Fully welded and hot-dip galvanized frame with 10 cross beams and 4 main beams
- ✓ Integrated ramp gutters
- ✓ Linked axles
- ✓ Completely equipped with LED lighting
- ✓ Steel fenders
- ✓ Strong expansion supports
- ✓ Standard U-profile for ramps
- ✓ Winch support holder on two sides



Usable length  
**506 cm**



Usable width  
**Min 204 cm - Max 224 cm**



Usable height  
**35 cm sides**



Weight  
**Max 3500 kg**

 **WORKS FOR YOU**



## This is what really strong looks like

This Platform trailer has been completely newly developed by our engineers. With robust and precise welding from the latest welding robots for continuous quality. Assembled by professionals. The end result? A robust trailer that can withstand quite a lot and is also practical to use. With this SARIS Platform Heavy Duty, no job is too tough!

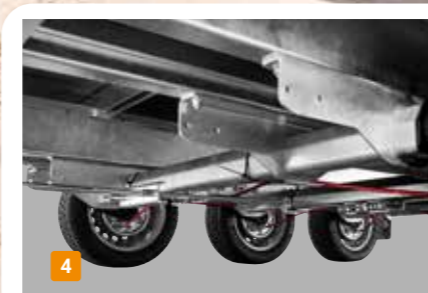

## The SARIS Platform Heavy Duty is standard equipped with:

- 1 Heavy Duty chassis: 10 cross beams and 4 main beams
- 2 Low floor for loading ease and stability on the road
- 3 Integrated ramp gutters
- 4 Linked axles
- 5 Heavy Duty jockey wheel (500 kg, supported)
- 6 Full LED lighting
- 7 Steel fenders
- 8 Winch support holder on two sides
- 9 Board set 35 cm

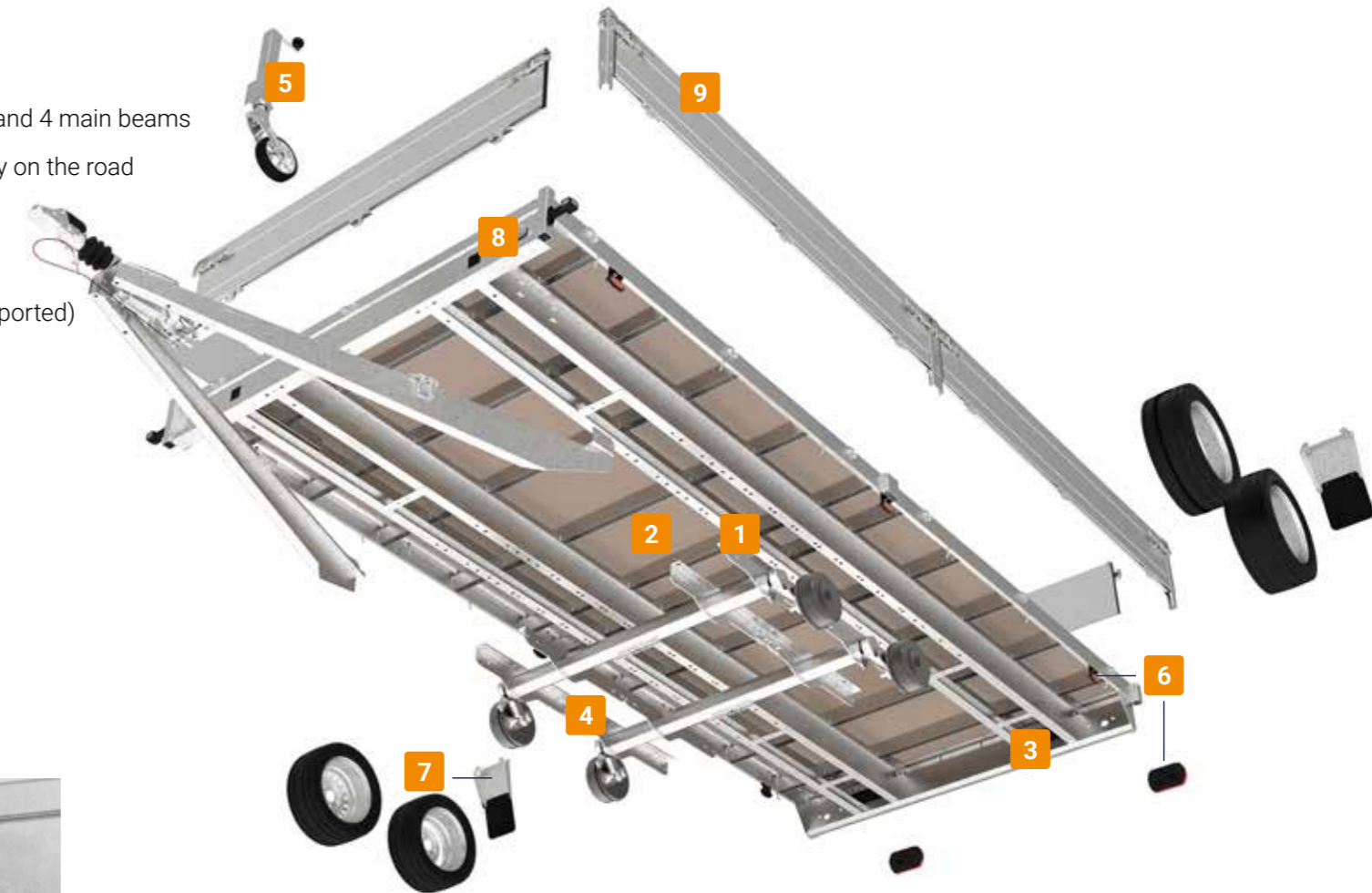

## Choose the SARIS Platform Heavy Duty that suits you!

Do you need a tandem or tridem axle? Do you want a standard width or would you prefer something a little wider? Choose the size that suits you best. Each size is available with aluminum or black boards (Black Edition).

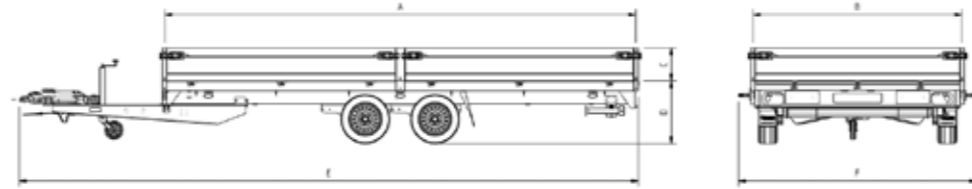

Technical information	PL 506 204 3500 2 HD	PL 506 204 3500 3 HD	PL 506 224 3500 2 HD	PL 506 224 3500 3 HD
Length (A) (cm)	506	506	506	506
Width (W) (cm)	204	204	224	224
Height of side wall (C) (cm)	35	35	35	35
Loading floor height (D) (cm)	67	67	67	67
Total length (E) (cm)	665	665	666	666
Total width (F) (cm)	236	236	255	255
Total weight (kg)*	3500	3500	3500	3500
Own weight (kg)	888	962	918	990
Load capacity (kg)	2612	2538	2582	2510
Tyre size	195/50R13C	195/50R13C	195/50R13C	195/50R13C
Single/Tandem/Tridem axle	Double	Tridem	Double	Tridem
T-shaped tow bar or V-shaped tow bar	V	V	V	V
Braked/Unbraked	Braked	Braked	Braked	Braked

\* Can be set to lower gross trailer weight rating.

## Basically the best

We supply the SARIS Platform Heavy Duty with reinforcement as standard. We dare to say that this trailer has the best price-quality ratio of its kind.



SARIS PL 506 224 3500 3 HD Black Edition



SARIS PL 506 224 3500 2 HD



## Options\* For those looking for just that little bit of extra.

- 1 Black Edition (black rims, black boards)
- 2 Sides 35 cm Black Edition
- 3 Shock absorbers
- 4 Spare wheel incl. support
- 5 Floor covered with steel plate (204: 2 pieces, 224: 3 pieces)
- 6 Reinforced winch support
- 7 Leaf springs (incl. shock absorbers)
- 8 Heavy Duty jockey wheel (500 kg) with support
- 9 Strong expansion supports
- 10 Integrated SARIS safety aluminum ramps
- 11 Railing
- 12 Winch



1 SARIS PL 506 224 3500 3 HD Black Edition



7



9



10



11



12



Build your trailer online!  
Go to: [www.saris.net](http://www.saris.net)

## Accessoires\*\*

- 1 SARIS Safety ramp (2.5 m - 1400 kg per ramp)
- 2 Spare wheel incl. support
- 3 Trailer net (large mesh)
- 4 High frontrack
- 5 Flat vinyl cover (light grey)
- 6 High vinyl cover (light grey)
- 7 Security lock



1



3



4



6



7



How does your trailer stay in perfect condition?  
Read more about our Service & Warranty  
at [www.saris.net](http://www.saris.net)

\* Can be set to lower gross trailer weight rating.



Your SARIS dealer:

## Commitment

### Commitment

Our entire trailer production process is characterised by commitment. We work continuously on improving our trailers, based on experience, expertise and craftsmanship. Reliable products made by a reliable company. This has been our culture for more than 60 years and it produces top quality and clear agreements with customers and suppliers.

## Cooperation

### Cooperation

SARIS builds trailers and works on long-term relationships with suppliers, dealers and end users. We have confidence in our business contacts and listen to them. This cooperation produces innovative products, with which we help our partners to be successful. Customers and dealers are of central importance at SARIS and they can always depend on the best service and quality.

## Craftsmanship

### Craftsmanship

SARIS trailers are manufactured by craftsmen, for craftsmen. The foundation for this is a well-thought-out design, with a keen eye for detail and design. We use only the best materials and make quality products in accordance with certified processes. A SARIS trailer is built for you to move mountains.

